

Outside Dimension(2 μ m-30W)

UNIT:mm

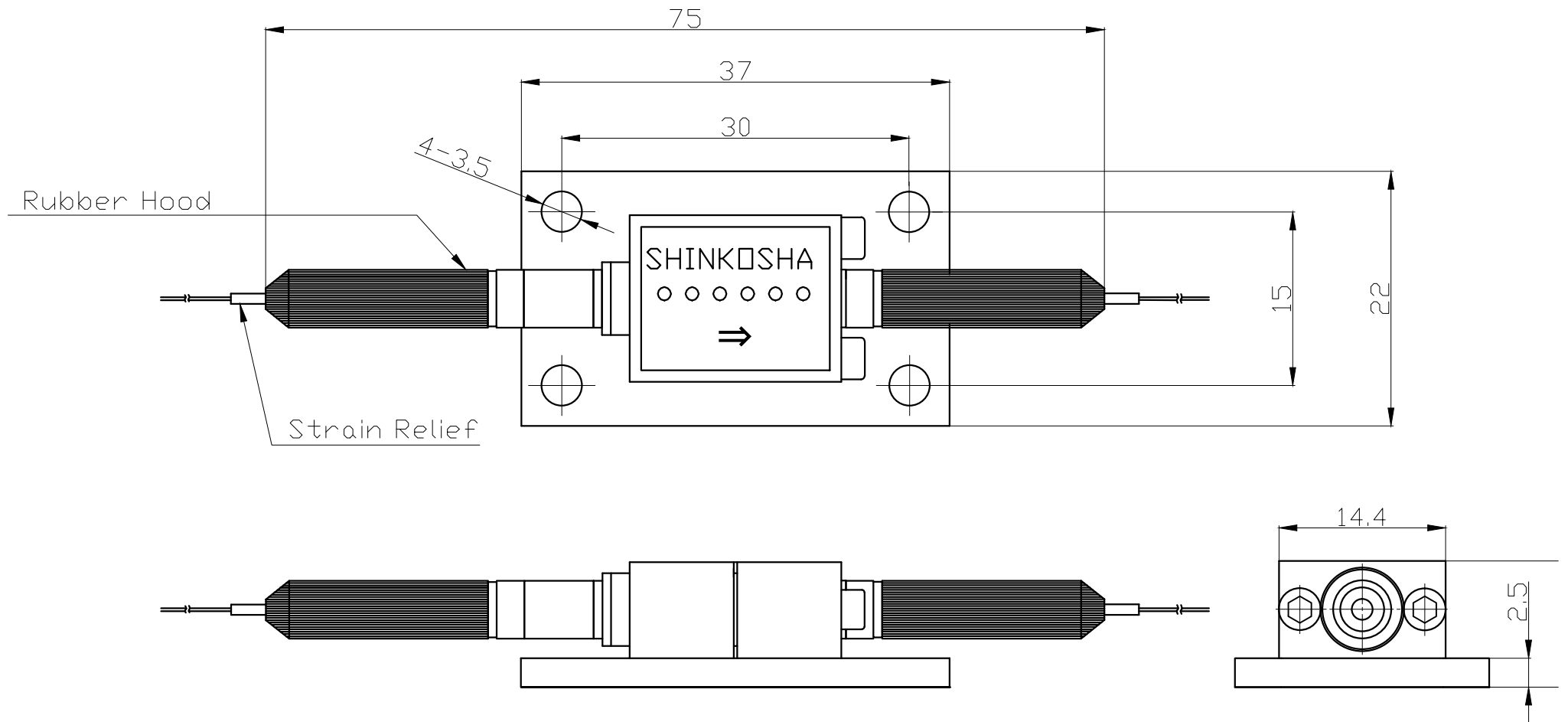

SHINKOSHA Co.,Ltd.